



**Auron 40**

**Description:**

B40 features an IP65-rated waterproof light engine, ensuring stable performance while minimizing costs. With versatile optics, CCT & wattage selectable, and plug & play sensor, it's perfect for shopping centers, supermarkets, warehouses, factory production areas, and aisles.



**Model: B40**

**Optical:**

CCT: 2CCT Selectable 4000K-5000K  
 Lumens : 13500 to 45000lumens  
 LED Type: LED 2835  
 CRI: Ra80

**Electrical:**

Rated Power: 90W to 300W  
 Input voltage: 100-277VAC, 120-347VAC, 277-480VAC  
 Beam angle: 60°/85°/105° selectable  
 Power factor: >0.95  
 Control: ON/OFF, Microwave, PIR sensor

**Life:**

Lumen maintenance: @Ta=25° 100800hrs-L80  
 160800hrs-L70  
 Warranty: 5 Years  
 Operating Temperature °C/°F -30° to+50°/ -22° to +122°

**General:**

Dimmable Solution: NA  
 IP: IP65  
 IK: 08  
 Operating Temperature: -30to+50 / -22 to +122  
 Finish color Availability: White  
 Applications: Warehouse /Industrial facility /Exhibition center  
 Shopping Mall / Gymnasium /Toll Station

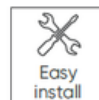
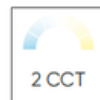
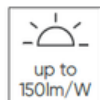
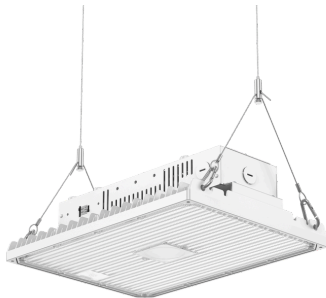
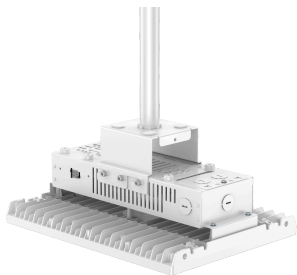



**Auron 40**

**Ordering Table**

**Sample: B40-150-277-T1-MS-S**

Model	Watt	Input voltage	Beam angle	Control	Installation
B40	90/120/150: 150 180/240/300: 300	120-277: 277 120-347: 347 277-480 :480	30°X100° T1 60°X100° T2 80°X100° T3 110° T4	Microwave sensor: Ms PIR Sensor: Ps	Rod : R Cable :C Surface mount :S

**Specification**

Model No	Size(mm)	Watt(W)	CCT(K)	CRI	LPW @5000K Ra80	Lumens (lm)	Voltage (Vac)	Beam Angle
B40-150WS	333X253X102	150/120/90 Selectable	4000,5000 Selectable	80	150	Up to 22500	120-277 120-347 277-480	30x100° 60x100° 80x100° 110°
B40-300WS	663X253X117	300/240/180 Selectable	4000,5000 Selectable	80	150	Up to 45000	120-277 120-347 277-480	30x100° 60x100° 80x100° 110°

**Different installation**

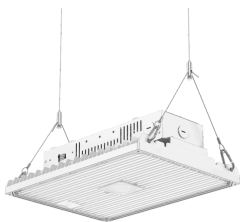

Suspend with cable

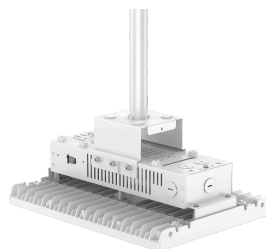

Suspend with Rod

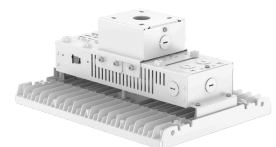

Surface mount



### Auron 40

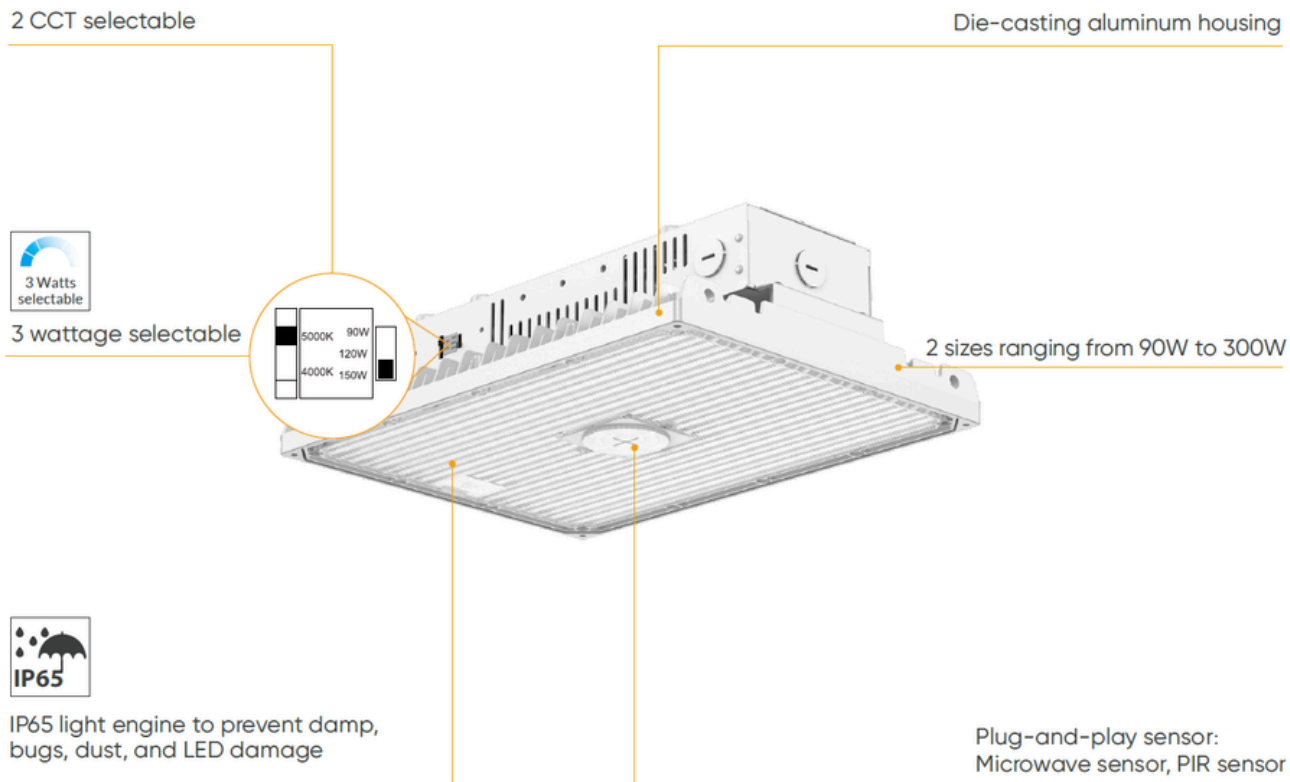

### Mounting Option



Suspension Mounting

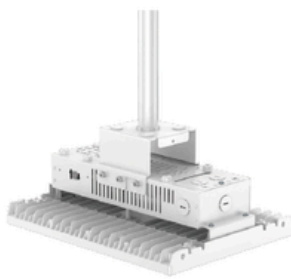

Pendant Mounting



Surface Mounting



**Auron 40**

**Accessories**



Suspension rope  
Code: SL-L09-01

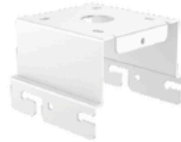

Surface mounting bracket  
Code: BC-L40-01



Pendant mounting bracket  
Code: BC-L40-02



Microwave sensor  
Code: SR-H30-01



PIR sensor  
Code: HN074-01VRPH



CASAMBI ready wireless controller  
Code: UP-CN01



Remote controller  
Code: HD05R

**Photometry**

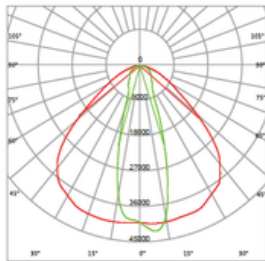

30×100°

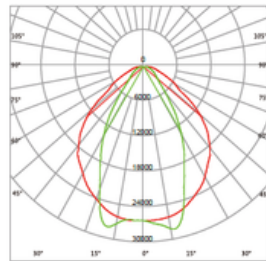

60×100°

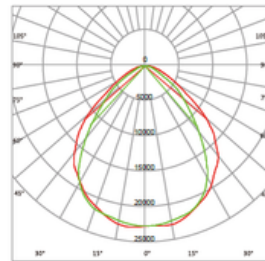

80×100°

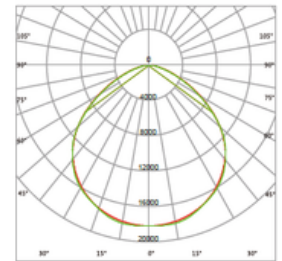

110°



**Auron 40**

**Dimensions**

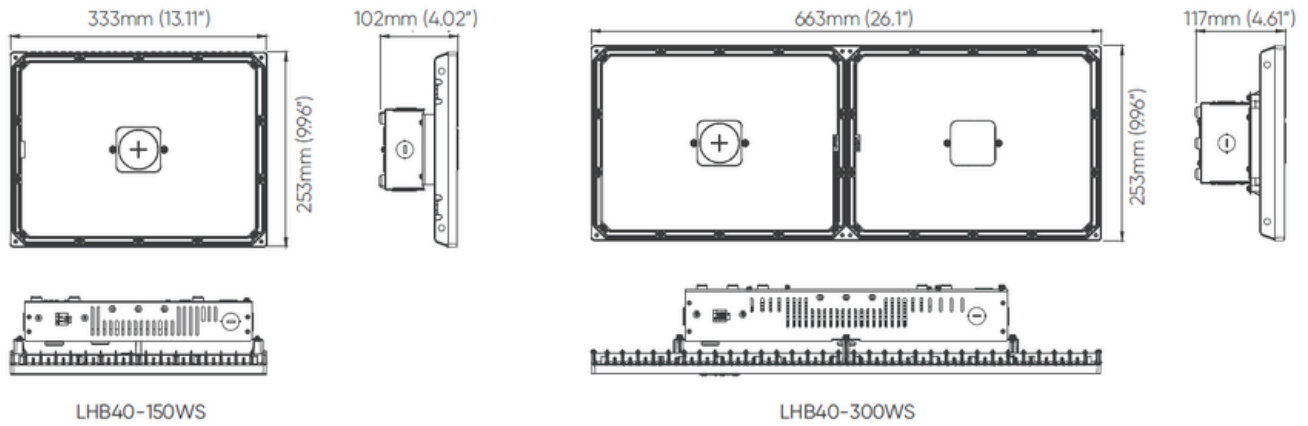

**Applications**

