



RECESSED LED STAIR LIGHT & WALL LIGHT



Description:

The concrete pour step/wall light offers a sleek and contemporary lighting solution for concrete structures, retaining walls, steps, and stairs. With its low trim profile, it blends seamlessly with the surrounding surfaces. This fixture is highly popular due to its decent power and lumens output. Its easy installation and low maintenance make it a practical choice. The concrete pour step/wall light enhances the ambiance and safety of outdoor spaces effortlessly, adding a stylish touch to any environment.

Model: SPL030624003SKP

Optical:

CCT:	3000
Light source:	3×2W OSRAM
Luminance:	CW=400 WW=285
LED Type:	SMD
CRI:	>80



Electrical:

Rated Power:	5.7W
Input voltage:	24VDC
Lens degree(°)Θ1/2:	45°/35°
Operating current (MA):	24V=200
LED Driver:	Constant Voltage Input, Constant Current Output

Life:

Lumen maintenance:	50,000 Hrs
Warranty:	2 YEARS

General:

IK:	08
IP:	IP65
Finish color Availability:	Brushed Stainless steel
Certification:	cETLus
Operating Temperature:	-20°C~40°C
Dimmable support:	Triac PWM 1-10V Dali



TRIAC PWM 1-10V DALI



OSRAM





RECESSED LED STAIR LIGHT & WALL LIGHT

PRODUCT SIZE

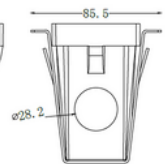
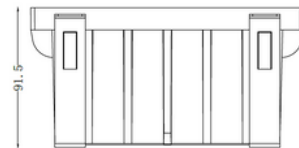
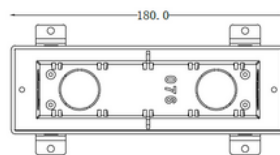
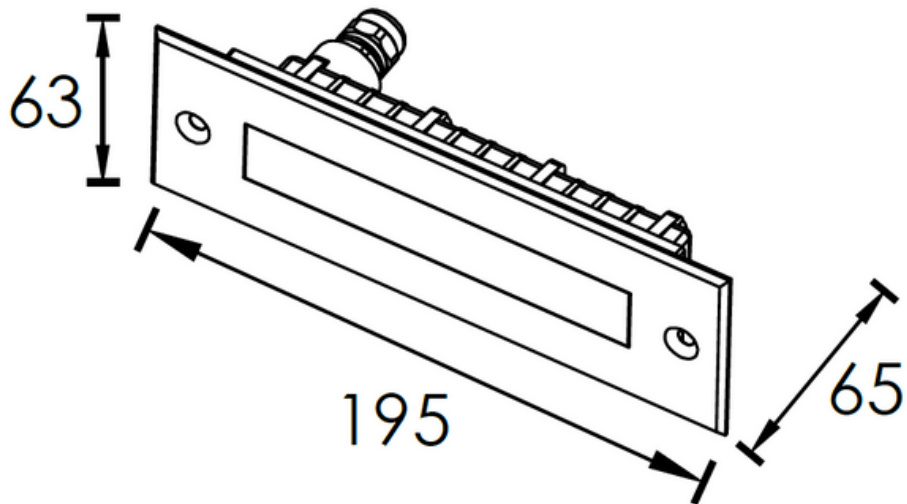



RECESSED LED STAIR & WALL LIGHT

PHOTOMETRIC

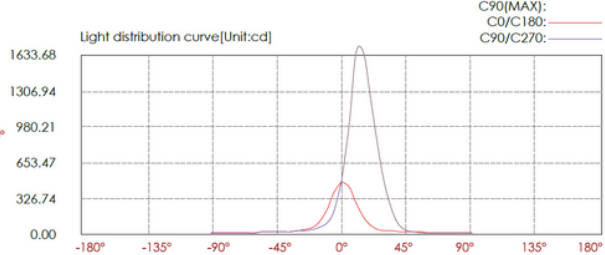
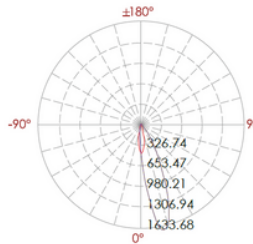
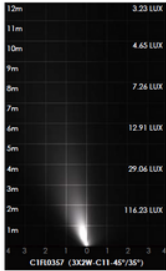

Lux distance cure

	Illuminance at a distance		Beam width	
	Center beam LUX	Beam width	V	H
2m	116.23 LUX	0.7m	0.6m	
4m	29.06 LUX	1.5m	1.3m	
6m	12.91 LUX	2.2m	1.9m	
8m	7.26 LUX	3.0m	2.5m	
10m	4.65 LUX	3.70m	3.10m	
12m	3.23 LUX	4.5m	3.8m	

Ver.Spread:21.2 Horiz.Spread:17.8

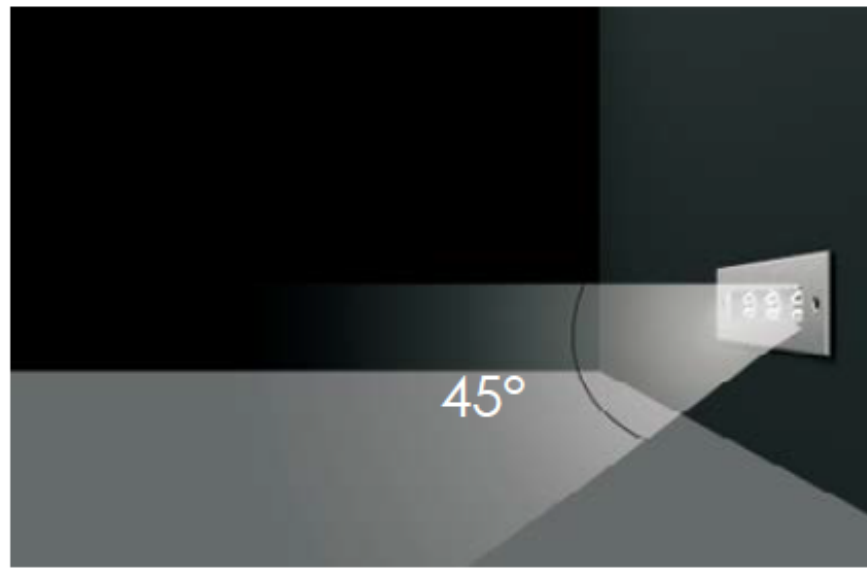

• Impression Drawing of Lens