

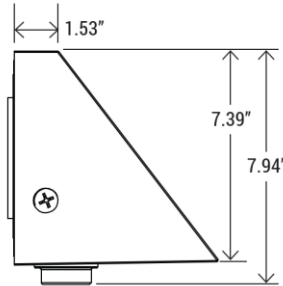

## LED ARCHITECTURAL WALL PACK

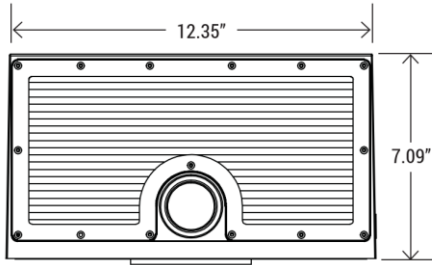

**WATT/CCT**  
SELECTABLE



### Description:

LED Architectural Wall Pack series, a versatile lighting solution designed for indoor and outdoor use, including wet locations. Ideal for museums, art galleries, shopping malls, and office buildings, these sleek fixtures combine aesthetics with high-performance LED technology. With a focus on energy efficiency, durability, and a stylish design, this series is perfect for enhancing architectural spaces and providing reliable illumination in any environment. Illuminate your surroundings with confidence and efficiency using our LED Architectural Wall Pack series.

### Specifications

Wattage	28W	42W	56W	70W	48W	72W	96W	120W
Lumens	4816lm	6930lm	8960lm	11410lm	8160lm	11880lm	15360lm	18840lm
Efficacy	172lm/W	165lm/W	160lm/W	163lm/W	170lm/W	165lm/W	160lm/W	157lm/W
CCT	3000K, 4000K, 5000K				4000K, 5000K			
CRI	70							
Input voltage	AC120-277V/277-480V							
Beam Angle	Type III: 93.5°x87.4° (option) Type IV: 94.3°x76.8° (standard) Type V: 107.3°x104.9° (option)							
Power factor	0.9							
Driver efficacy	90%							
Factory setting	70W & 4000K				120W & 4000K			
Lumen maintenance	ANSI/IES LM80-15 lumen maintenance L70 51000 hours L90 102000 hours							
Working temperature	-22°F~113°F							
Storage temperature	-40°F~176°F							
Environment	Wet location, IP65, IK09							
Cable	3 core, 18AWG (0.3m)							
Warranty	5 Years							
Dimming	0-10V							



85°C , 100mA Lumen Maintenance				
No of hours	1000 hrs	25000 hrs	50000 hrs	100000 hrs
Lumen maintenance factor	1	>0.96	>0.92	>0.85

THD and PF Test according to ANSI C82.77 @ 60Hz					
CCT Setting	Voltage	Current	Wattage	Power Factor	iTHD (%)
3000K	120	5956	70.63	0.9882	8.74
	277	0.2668	69.2	0.9364	8.81
4000K	120	0.5849	69.34	0.988	8.52
	277	0.2631	68.23	0.9363	8.66
5000K	120	0.5904	70.01	0.9882	8.69
	277	0.2532	69.32	0.9882	8.78
4000K	120	0.9948	119.12	0.9979	2.79
	277	0.4184	110.46	0.953	9.06
5000K	120	0.9995	119.7	0.998	2.57
	277	0.4198	110.83	0.9532	8.92

## Ordering Information:

Example: WAF-2457-3C-R3-UNV-B-P-M

Series	Watts (4 Watt Changeable)	CCT(K°) (Changeable)	Distribution
<b>WAF</b>	<b>2457:</b> 28/42/56/70W	<b>3C:</b> 3000/4000/5000K	<b>R3:</b> Type III
	<b>47912:</b> 48/72/96/120W	<b>2C:</b> 4000/5000K	<b>R4:</b> Type IV
			<b>R5:</b> Type V

Voltage	Finish	Control	Option
<b>UNV:</b> 120-277V <b>48:</b> 277-480V	<b>D:</b> Dark bronze <b>W:</b> White <b>B:</b> Black <b>S:</b> Silver	<b>P:</b> Photocell <b>O:</b> None	<b>M:</b> Bi-level microwave sensor <b>B8:</b> Battery backup 8W <b>B15:</b> Battery backup 15W <b>B8L:</b> Low voltage battery backup



## Options

<p>B8 : 8W Split Built-In Emergency Backup Battery LED Driver ①④</p>	<p>Output power: 8W, Input voltage 100-347VAC, WSD-EMS8W27-XX, Charging Time ≥24 Hours, Temperature Rating (Ambient): Li-ion 0°C to +50°C (32°F to 120°F) Battery Charging Current: 250mA, Output Voltage: 36-60Vdc</p>
<p>B15 : 15W Split built-in emergency Backup Battery LED Driver ①</p>	<p>Output power: 15W, Input voltage 100-347VAC, WSD-EMS8W27-XX, Charging Time ≥24 Hours, Temperature Rating (Ambient): Li-ion 0°C to +50°C (32°F to 120°F) Battery Charging Current: 350mA, Output Voltage: 36-150Vdc</p>
<p>B8L : 8Watt Emergency Backup battery LED driver ①⑤</p>	<p>Output power: 8W, Input voltage 100-347VAC, WSD-EMS8W27-XX, Charging Time ≥24 Hours, Temperature Rating (Ambient): Li-ion 0°C to +50°C (32°F to 120°F) Battery Charging Current: 350mA, Output Voltage: 36-150Vdc</p>
<p>M :Bi-Level microwave sensor ①③</p>	<p>12-24VDC &gt;50mA, DIM control 0-10V, Mounting Height Max 50ft (15 M),          Detection Radius 20% 50% 75%% 100% (1-8M),          Time setting 10s/1min/5min/10min/15min/20min/30min/60min          Light – control 24H/10LUX/30LUX/50LUX          Temp -4°F~ +140°(-20°C~ +60°C)          IP 65</p>

### Option Notes:

- 1 Sold separately
- 3 RC100 Remote controller Matched microwave sensor BR1810B-7
- 4 Available only for 28-70W & low-voltage models
- 5 For Low voltage models only



**B8**



**B15**



**M**



**RC100 Remote Control**



**B8L**



## Bi-level Microwave Motion Sensor

### SENSOR COVERAGE

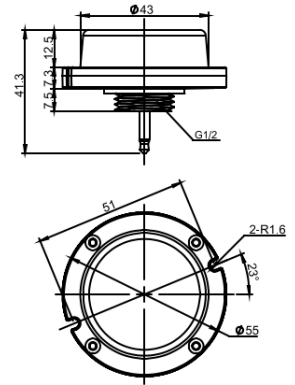
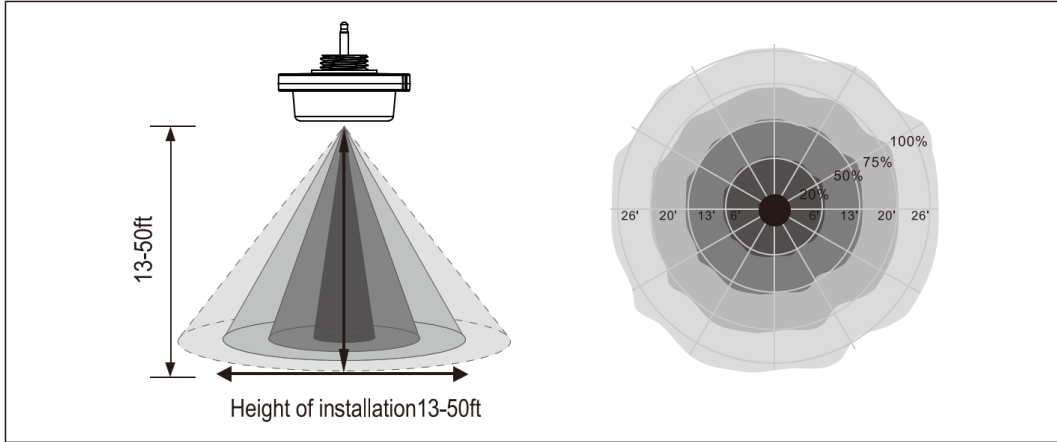

#### **⚠ WARNING**

**NOTE:** Warm up time is 15 seconds. After the sensor connects input power first time, the light will keep on 15 seconds, then go to dimming to work normally.

**NOTE:** Factory Default Setting: 100% sensitivity, Hold on time: 5 min, Daylight sensor is Kit, Dimming level: 30%, Dimming time: 60 minutes.

**NOTE:** Any setting changed by remote control, the led light that sensor connect will on/off as confirm.

### CORRIDOR FUNCTION

This function inside the motion sensor to achieve tri-level control, for some areas which require a light change notice before switch-off. The sensor offers 3 levels of light: 100% --> dimmed light (natural light is insufficient) --> off; and 2 periods of selectable waiting time: motion hold-time --> and stand-by period; Selectable daylight threshold and freedom of detection area.

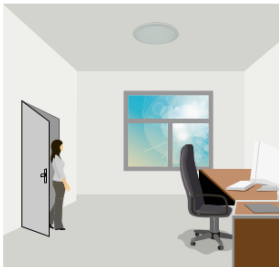

With sufficient natural light the light does not switch on when presence is detected.

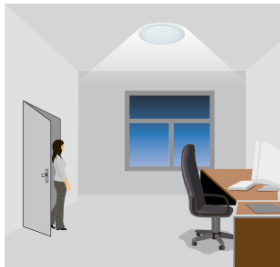

With insufficient natural light, the sensor switches on the light automatically when presence is detected.

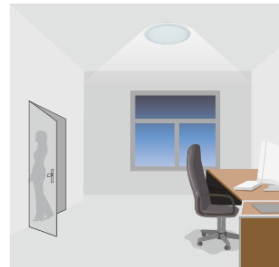

After hold-time, the light dims to stand-by level if the surrounding natural light is below the daylight threshold.



Light switches off automatically after the stand-by period elapses.





## Photometric

### TYPE III, 70W @ 5000K

LUMINOUS INTENSITY DISTRIBUTION DIAGRAM

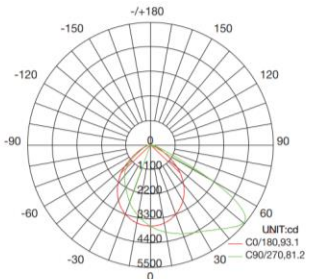

AVERAGE BEAM ANGLE(50%):87.1 DEG

C0 PLANE ISOLUX DIAGRAM (UNIT:lx)

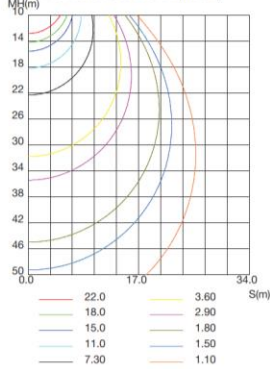

Flux out : 4903 l m

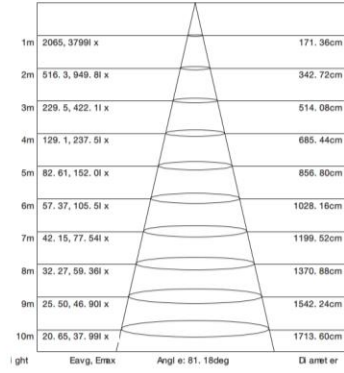

ISOLUX DIAGRAM

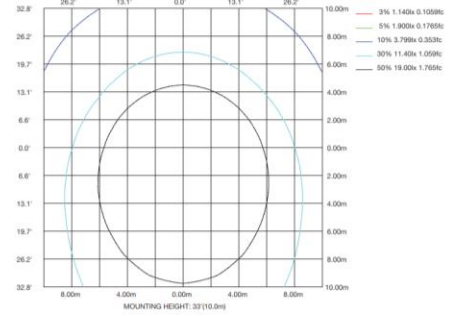

### TYPE IV, 70W @ 5000K

LUMINOUS INTENSITY DISTRIBUTION DIAGRAM

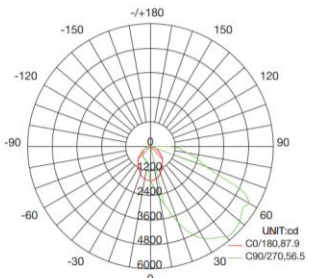

AVERAGE BEAM ANGLE(50%):72.2 DEG

C0 PLANE ISOLUX DIAGRAM (UNIT:lx)

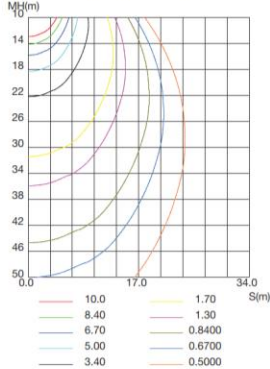

Flux out : 7445 l m

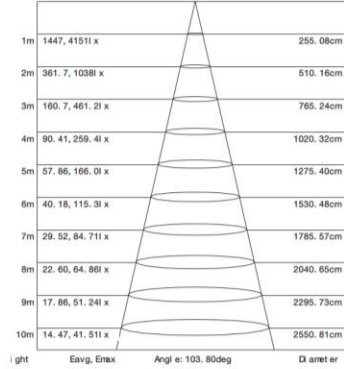

ISOLUX DIAGRAM

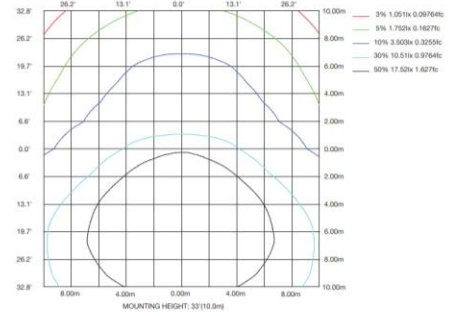

### TYPE V, 70W @ 5000K

LUMINOUS INTENSITY DISTRIBUTION DIAGRAM

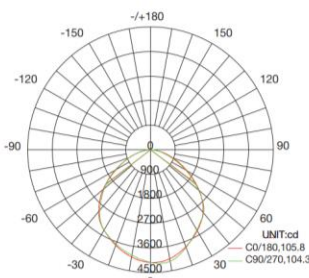

AVERAGE BEAM ANGLE(50%):105.1 DEG

C0 PLANE ISOLUX DIAGRAM (UNIT:lx)

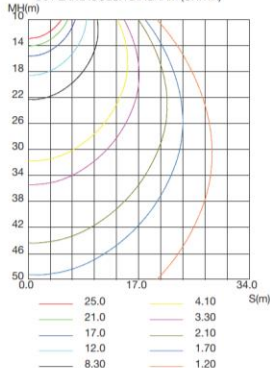

Flux out : 4903 l m

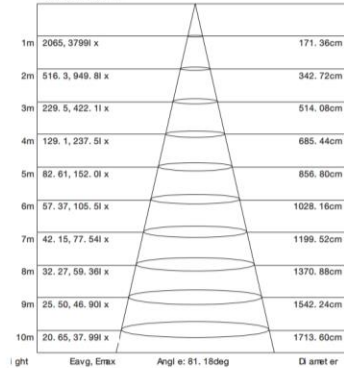

ISOLUX DIAGRAM

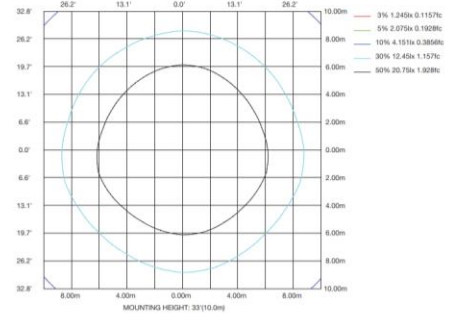





## Photometric

### TYPE III, 120W @ 5000K

LUMINOUS INTENSITY DISTRIBUTION DIAGRAM

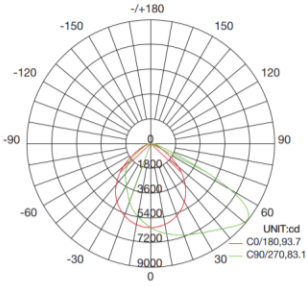

AVERAGE BEAM ANGLE(50%):88.4 DEG

C0 PLANE ISOLUX DIAGRAM (UNIT:lx)

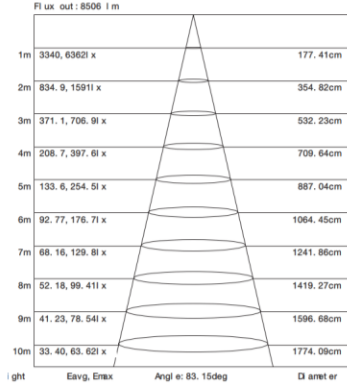
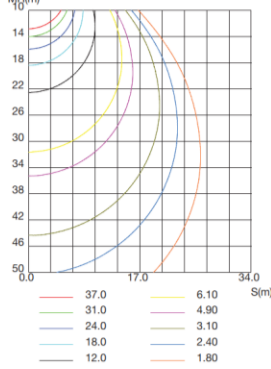

ISOLUX DIAGRAM

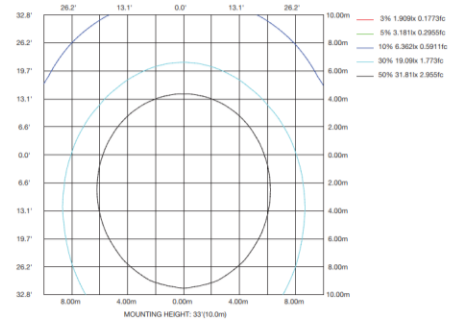

### TYPE IV, 120W @ 5000K

LUMINOUS INTENSITY DISTRIBUTION DIAGRAM

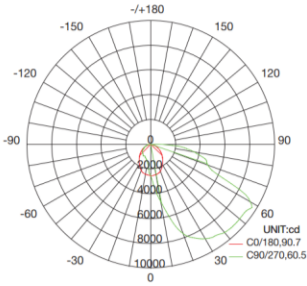

AVERAGE BEAM ANGLE(50%):75.6 DEG

C0 PLANE ISOLUX DIAGRAM (UNIT:lx)

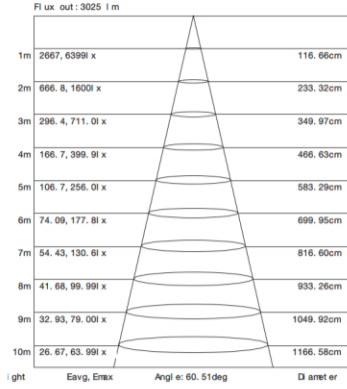
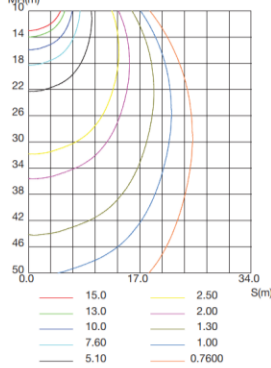

ISOLUX DIAGRAM

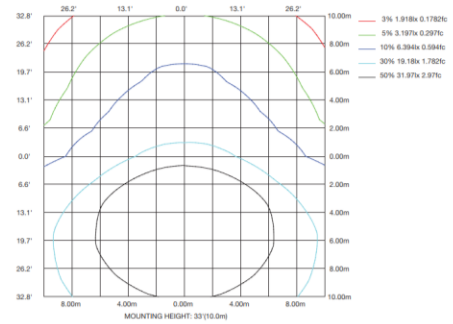

### TYPE V, 120W @ 5000K

LUMINOUS INTENSITY DISTRIBUTION DIAGRAM

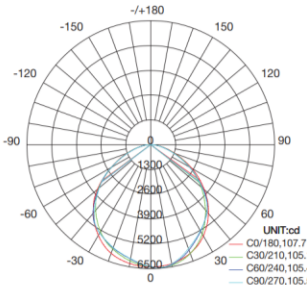

AVERAGE BEAM ANGLE(50%):105.9 DEG

C0 PLANE ISOLUX DIAGRAM (UNIT:lx)

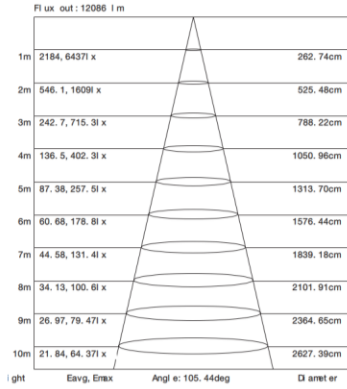
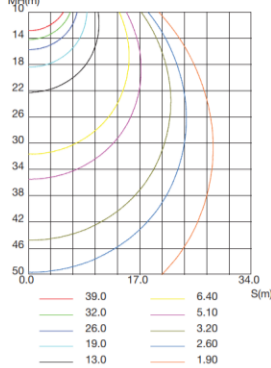

ISOLUX DIAGRAM

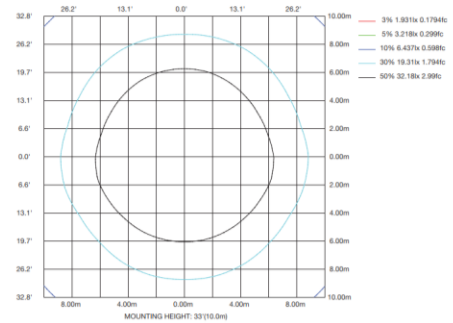

## Features and Specifications:

### Application:

The WAF series is versatile and suitable for various outdoor lighting applications. It can be utilized for security lighting along building exteriors and to illuminate the perimeter, enhancing visibility and safety. Additionally, it's ideal for parking lot lighting, walkways, and paths, ensuring safe navigation for pedestrians and vehicles. Moreover, it's well-suited for loading docks and freight yards, providing adequate illumination for operations. Furthermore, it can serve as architectural accent lighting, enhancing the aesthetics of buildings. With medium lumens typically ranging from 3300 to 7100 lm, the WAF series is commonly used for illuminating these areas effectively and efficiently.

### Construction:

A standout feature of the WAF Wall Pack series is its high-performance die-cast heat sink, effectively transferring heat from the light engine to the surrounding environment. This innovative design not only draws heat away from the fixture but also, significantly extends the lifespan of the LEDs. Crafted from premium die-cast aluminum, this cooling system ensures superior quality and enhanced cooling, maintaining LED junction temperatures below 85°C for optimal performance and durability.

### Finish:

The WAF Wall Pack series boasts a diverse array of finishes including dark bronze, white, black, and silver; providing options to suit various customer tastes. Utilizing advanced powder coating technology, these finishes are meticulously applied to ensure a smooth and beautiful outcome. This attention to detail enhances the aesthetics of the fixtures, elevating the appearance of any space while meeting the discerning preferences of our customers.

### Optics:

The WAF series optical lens, constructed with high-quality polycarbonate (PC) material, is engineered to deliver a soft and uniform lighting pattern. This material is chosen for its durability, clarity, and ability to diffuse light effectively, ensuring optimal performance and longevity of the lens. The light engine integrated into the WAF series offers versatile lighting options with configurations available in 3000K, 4000K, and 5000K. This flexibility allows users to tailor the lighting to suit different environments, preferences, and tasks. One of the standout features of the WAF series is its excellent optics design. This design has been meticulously crafted to enhance light utilization and distribution, resulting in improved efficiency and evenness across the illuminated area. By maximizing the utilization of light output, the WAF series ensures that every corner of the space receives sufficient illumination without any glaring hotspots or shadows.

### Electricals:

The WAF series features LED technology with high luminous efficiency of 140lm/W at 4000K and a long working life of over 50,000 hours. Its high-efficiency LED driver supports wide input voltage (AC120-277V) with 90% efficacy and 0.90 power factor. Additionally, it offers continuous 1-10V dimming for adjustable brightness. This combination ensures reliable, energy-efficient lighting for diverse indoor applications.

### Installation:

To install the WAF series wall pack, start by unpacking and locating the mounting plate with the hook for hanging the luminaire during wire connections. Once found, hang the fixture from the mounting plate hook and connect the AC line, then tighten the mounting plate screws securely. For optimal installation and to prevent water or moisture from penetrating the fixture or electrical box, apply waterproof glue seal where the light encounters the wall. If there's a photocell on the side of the fixture, it can be pulled out or unscrewed. If removed, use the spare cap plug to cover the hole. For wiring guidance, refer to the wiring diagram provided in the datasheet accompanying the fixture. To adjust the wattage and CCT (correlated color temperature), consult the diagram in the datasheet for proper guidance.

### Certificates:

The WAF series proudly carries a UL certificate, providing assurance that the product meets both local and federal environmental and safety regulations. The UL Mark signifies that the manufacturer adheres to rigorous standards for quality and safety, offering peace of mind to consumers. Additionally, the WAF series is ROHS compliant, holding a certificate that ensures compliance with regulations restricting the use of specific hazardous materials in electrical and electronic products (EEE). The WAF series is designed as a wet location-rated product, making it an ideal outdoor lighting solution. Its robust construction ensures durability and reliability in various weather conditions. Moreover, the WAF series holds DLC Premium approval, signifying its ability to offer enhanced energy savings while delivering superior light quality and controllability performance that surpasses DLC Standard requirements. This certification highlights the product's efficiency, reliability, and adherence to stringent industry standards, making it an excellent choice for outdoor lighting applications where energy efficiency and performance are paramount. IFAM7 Ref. no. E354939-20220121, CSA C22.2 no. 205021.

### Warranty:

Your purchase of the WAF series includes a 5-year limited warranty. Include 1 year replacement warranty by distributor. This warranty covers any defects in materials or workmanship under normal use during the warranty period. However, it's important to note that the warranty does not cover failures caused by unprofessional installation or if the product has been installed in an environment other than that recommended by the manufacturer. The warranty period begins from the date of the issued invoice. This ensures that customers have coverage for a substantial period, providing peace of mind regarding the product's quality and reliability.