



### Power Lite 5

#### Description:

Introducing our 5" LED Down Light, engineered for high-performance and versatility in commercial settings. With its impressive lumen output, this down light ensures bright and efficient illumination for any space. Its IC-rated, airtight design makes it suitable for both dry and damp locations, ensuring reliability and safety across diverse environments. Crafted from durable ADC12 die-cast aluminum, the housing promises robust construction and long-lasting performance. The down light is available in a variety of trims and reflector colors, allowing you to customize the look to perfectly align with your project's aesthetics. For added convenience, a rough-in plate can be ordered separately, making installation straightforward and adaptable to your specific needs. Perfect for commercial applications, this LED down light combines functionality, durability, and flexibility, making it an ideal choice for your next project.



**Model: DNLWP15270735K55WHLB**

#### Optical:

CCT:	27K,3K,35K,4K,5K,6K, 3CCT,5CCT
Lumen out put:	Up to1350LM
Efficacy:	85lm/w
CRI:	>80



#### Electrical:

Rated Power:	7W, 9W,10W,12W,15W
Input voltage:	120Vac/120-277Vac/100-347Vac,50/60Hz
Beam angle:	110°



#### Life:

Lumen maintenance:	50,000hurs
Warranty:	2 Years

#### General:

Dimmable Solution:	TRIAC/0-10V/Dali
IP:	IP44
Application:	Ceiling Recess Mount
Finish color Availability:	White /Black /Silver
Material:	Die Casting ADC12
Certification:	cETLus



DAMP  
LOCATION



IC  
RATED

SSS  
AIRTIGHT

DIMMABLE



**Power Lite 5**

**REMODEL**



**NEW CONSTRUCTION**



**TRIM COLOR**

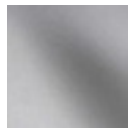

**Matt Silver**

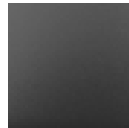

**Matt Black**



**Matt White**





**Power Lite 5**

**INSTALLATION**

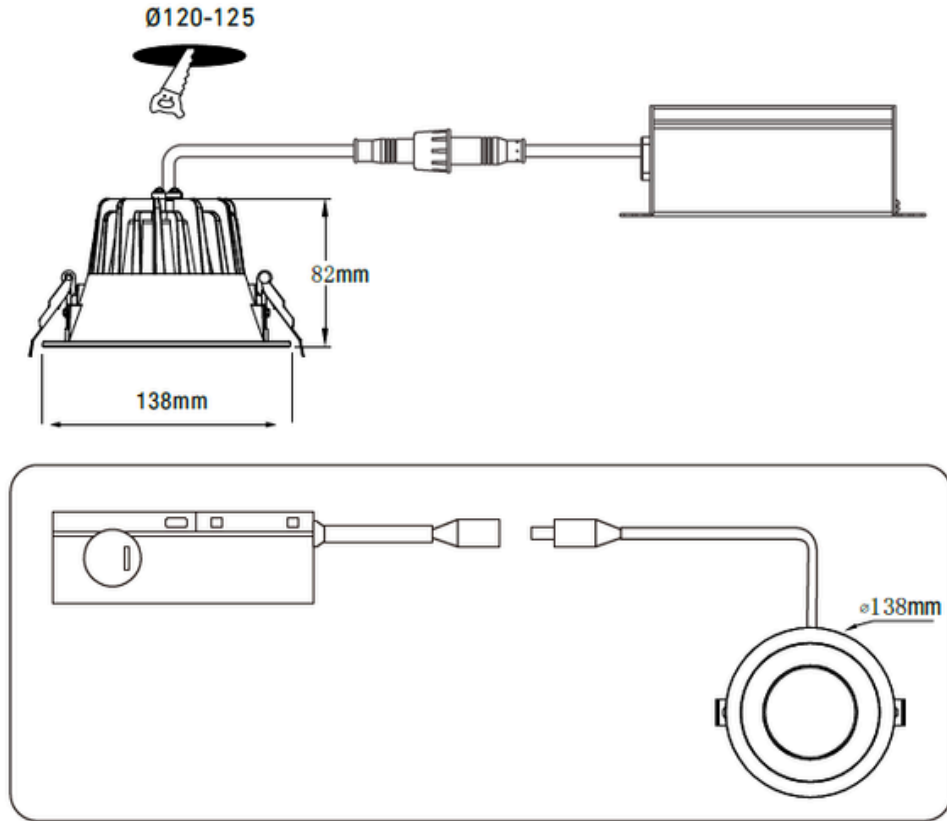

**Fig.1**

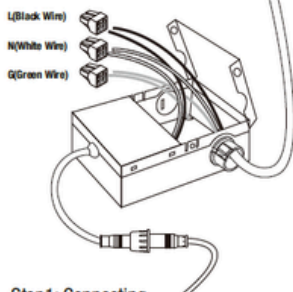

**Step1: Connecting**

Using wire nuts, connect green ground wire of cable to green wire on box. Connect white wire of cable to white of box. Connect black wire of cable to black wire of box.

**Fig.2**

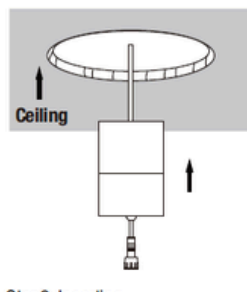

**Step2: Inserting**

Insert hardwire box through the mounting hole.

**Fig.3**

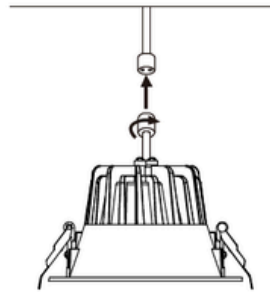

**Step3: Twisting**

Connect the fixture to the hardwire box by inserting and twisting the male/female connectors.

**Fig.4**

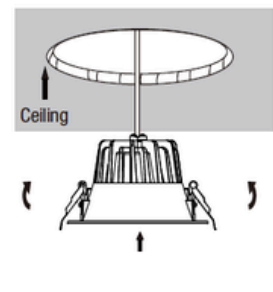

**Step4: Pushing**

Push spring loaded clips on the fixture upwards and insert fixture base in to the mounting hole. Release the clips and fixture will be pulled flush to the ceiling.



**Power Lite 5**

**PHOTOMETRY**

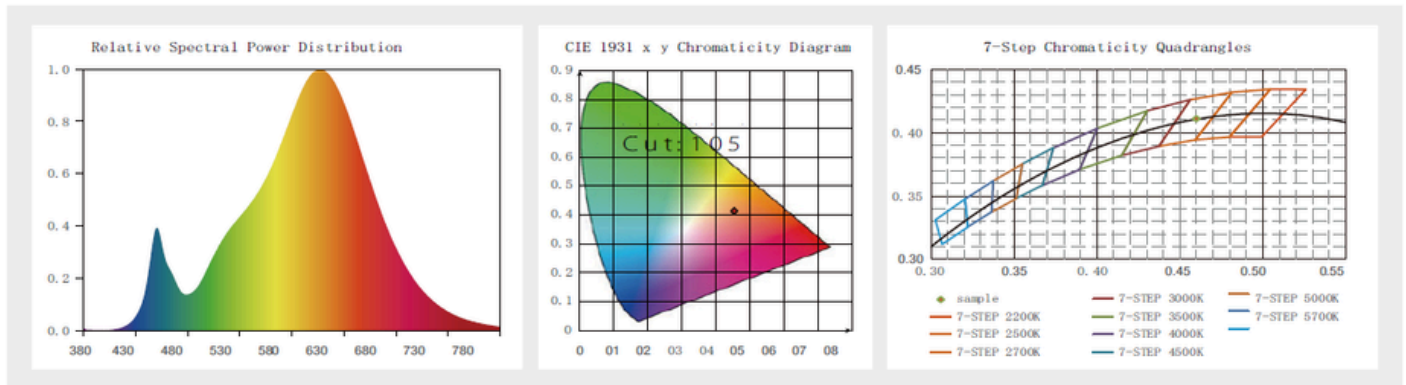

**ORDERING TABLE**

Sample

**DNLWP-NC-07-595-SV-3K-WHT**

Series	Installation Type	Wattage	Efficacy	Driver	CCT	CRI	Reflector
<b>DNLWP</b>	<b>NC</b> New Construction <b>RM</b> Remodel	07 (07W)	595lm	SV 120VAC Phase DIM UNV 120-277 0-10V Dim DALI 120-277 DALI DIM	27 2700K	85	<b>WHT</b> White <b>SLV</b> Silver <b>ALF</b> Aluminum Ref <b>BLK</b> Black Baffled
		09 (09W)	765lm		30 3000K		
		10 (10W)	850lm		40 4000K		
		12 (12W)	1020lm		50 5000K		
		15 (15W)	1350lm		60 6000K		